

# SWITCH CATALOG



# BASIC SWITCHES









## Precision Snap Action Switches

### FEATURES

- Snap action
- Plastic, flame resistant case
- Single, double and three pole circuits
- Eight types of terminations
- Long life
- 1000 V rms dielectric strength
- Current capacities from dry circuit to 40 amperes
- Military approved
- Environmentally sealed
- UL recognized
- Low movement differential and operating force types available
- Stacking and gang mounting capabilities

### SELECTION AND SPECIFICATIONS TABLE

#### SERIES

Image	Series	Circuit	Electrical Rating Life	Terminals	Description	Characteristics					
						Catalog Number	Operating Force (Max.)	Release Force (Min.)	Pretravel (Max.)	Diff. Travel (Min.)	Over Travel (Min.)
	<b>Series D</b>	4 CKT Dbl. Brk.	15 amps, 125/250VAC, 60/400Hz 30VDC Resistive 10 amps, 125/250VAC, 60/400Hz 30VDC Inductive 100,000 operations mechanical life, 50,000 operations electrical life	End Solder Side Solder Side Solder End Solder Side Solder Side Solder	Standard  Non-Simultaneous Break MS25348-1 MS25349-1 Reset Type	D4-4 D8-4 D8-9 D4-44 D8-44 D8-344	28+/-5 oz 2.18 lbs 1.25 lbs	3 oz. —	.060 in.	.028 ±.007 in.	.018 in.
	<b>Series E-4 &amp; EM</b>	1 PDT	Operations, Min. 150,000 2.5 amps. 125/250VAC Res. & Ind. 100,000 5.0 amps. 125/250VAC Res. & Ind. 50,000 4.0 amps. 30VDC Resistive 50,000 2.5 amps. 30VDC Inductive	Solder  Double Turret	Standard (Dust, Splash-proof)	E4-103  EM-4111	200 grams	40 grams	.020 in.	.003 in.	.007 in.
	<b>Series EF</b>	1 PDT	150,000 operations at 2.5 amps, 125/250VAC 100,000 operations at 5.0 amps, 125/250VAC 50,000 operations at 2.5 amps, 30VDC Inductive 50,000 operations at 4.0 amps, 30VDC Resistive	Wire Leads  Wire Leads	Standard  High-Temp. (-65°F to +300°F)	EF-103  EF-110	5-17 oz.	4 oz.	.050 in.	.004 in.	.003 in.
	<b>Series G</b>	2 CKT (1 PDT) Mom.	125/250VAC, 30 amps Resistive 125/250VAC, 20 amps Inductive 125/250VAC, 10 amps Motor 28VDC, 40 amps Resistive 28VDC, 30 amps Inductive 28VDC, 15 amps Motor 25,000 Operations Min.	Solder	MS25357-1	G3-44	50.75 oz	6 oz.	0.093 in.	.055 +/- .010 in.	.015 in.
	<b>Series K</b>	6 CKT 3 N.O. 3 N.C.	15 amps, 125/250VAC, 60/400 Hz, 15 Amp Ind., 30VDC Resistive, 15 amps 10 amps, 30VDC Inductive 50,000 operations	Side Solder	Standard U.L. Listed - 30A, 250VAC MS25356-1 MS25353-1, Reset Type	K3-4 K3-12 K3-44 K3-344	56 oz.	4 oz.	.060 in. .075 in.	.028 +/- .007 in. .036 in.	.015 in.
	<b>Series S</b>	2 CKT Dbl. Brk.	750,000 operations at 10 amps, 125VAC 10,000 operations at 1 amp, 125VAC pilot duty 200,000 operations at 10 amps, 30VDC res & ind  U.L. Listed for 10 amps, 125/250VAC, 1/2 amp, 125VDC (1/2 hp, 125/250VAC) Military rated for 10 amps 125/250VAC, 30VDC Ind.	End Solder End Screw Side Solder	Standard	S1-4 S2-4 S3-4	12+/-3 oz.	4 oz.	.060 in.	.020 +/- .005in	.015in
		2 CKT Dbl. Brk.	50,000 minimum operation 125VAC, 10 amps Resistive & Inductive 30VDC, 10 amps Resistive & Inductive 125VAC, 6 amps motor 28VDC, 6 amps motor	End Solder End Screw	MS25342-1, .027 max move. diff. MS25344-1, .027 max move. diff.	S1-44 S2-44	1.25 lbs  12 +/-3 oz	4 oz.	.060 in.	0.027	.015 in.
		1 PNC Dbl brk. 1 PNO Dbl brk.	750,000 operations at 10 amps, 125VAC 10,000,000 oper. at 1 amp, 125VAC pilot duty 200,000 operations at 10 amps, 30VDC Inductive Military rated for 10 amps 125/250VAC, 30VDC	Side Solder End Screw Side Solder Side Solder	MS25343-1, .020+/- .005 move diff Standard .020 +/- .005 move. diff. Standard .010 +/- .004-.003 mv df U.L. Listed	S3-44 S2-25 S3-5 S3-6	19 oz. 15 oz. 15 oz. 15 oz.			+/- .020in	.015 in.

# BASIC SWITCHES

## Precision Snap Action Switches

### APPROXIMATE DIMENSIONS

Terminal Styles (Other terminations available)

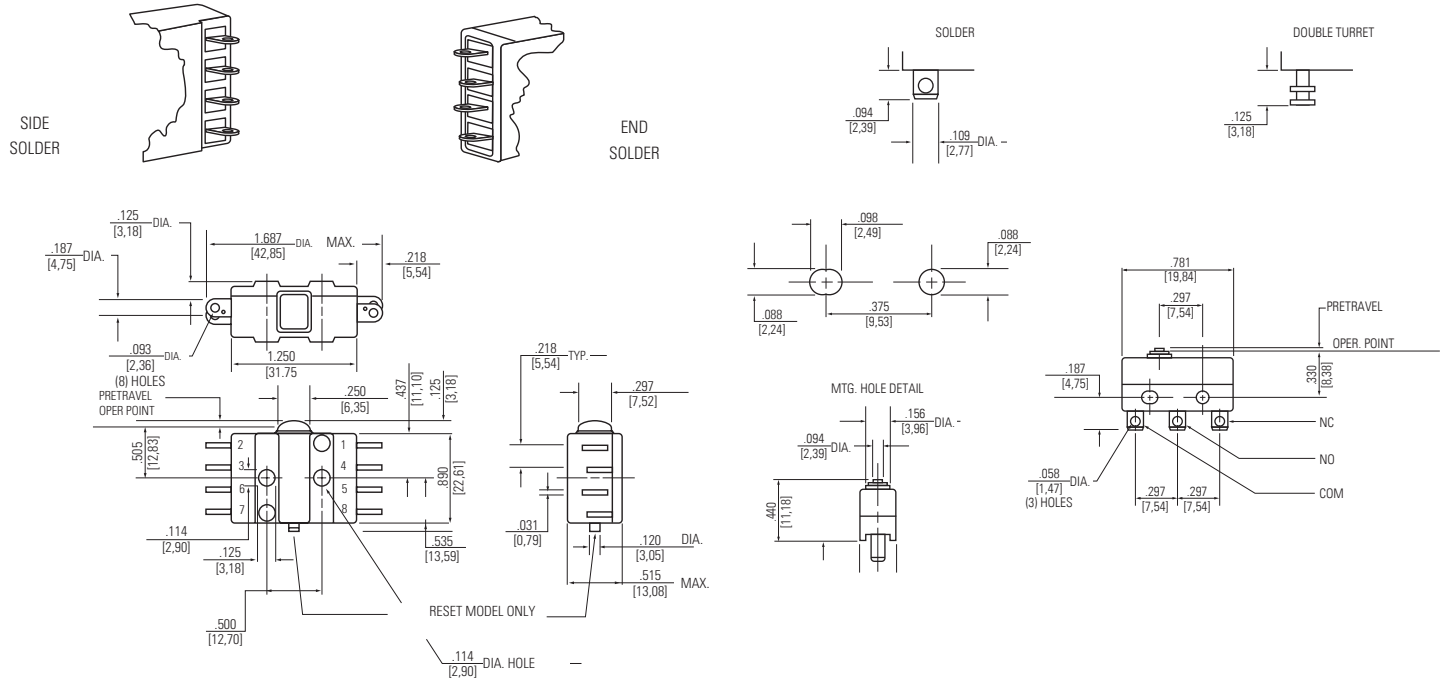

**Series D**

**Series E4 and EM**

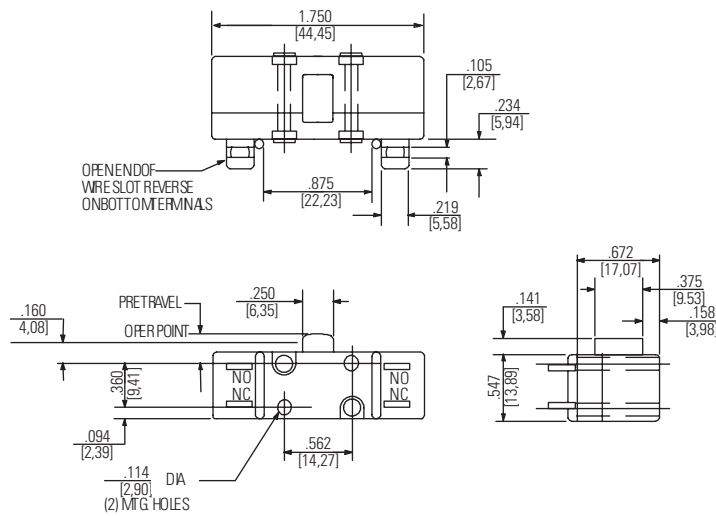

**Series G**

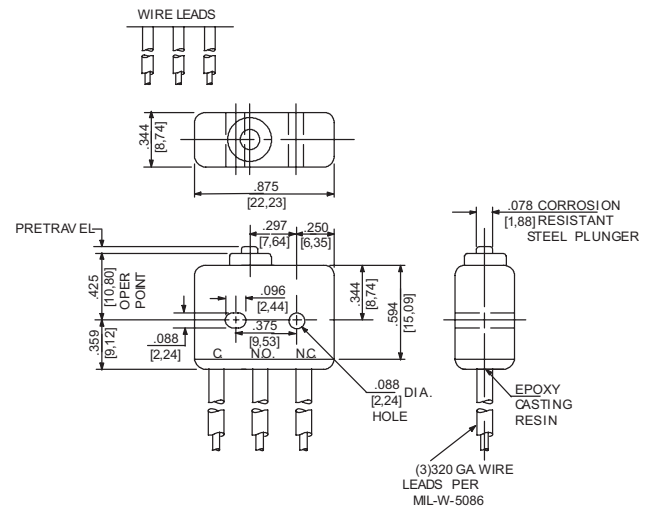

**Series EF**

### STANDARD

0.00 = inches

[0,0] = mm

Dimensions for reference only.

# BASIC SWITCHES

## Precision Snap Action Switches

### APPROXIMATE DIMENSIONS

Terminal Styles (Other terminations available)

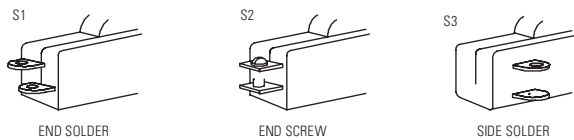

OTHER TERMINATIONS AVAILABLE

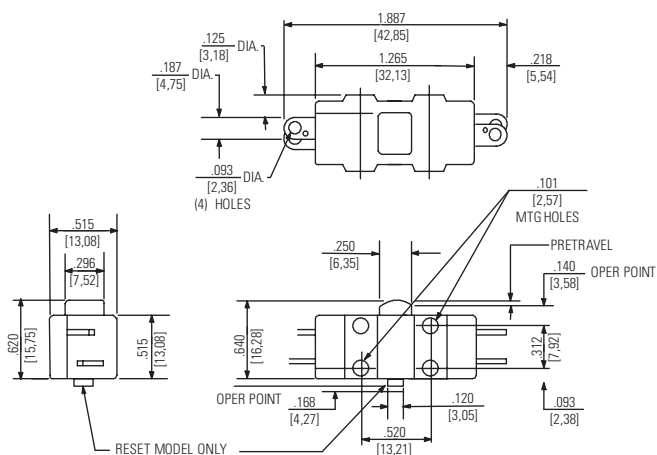

Series S

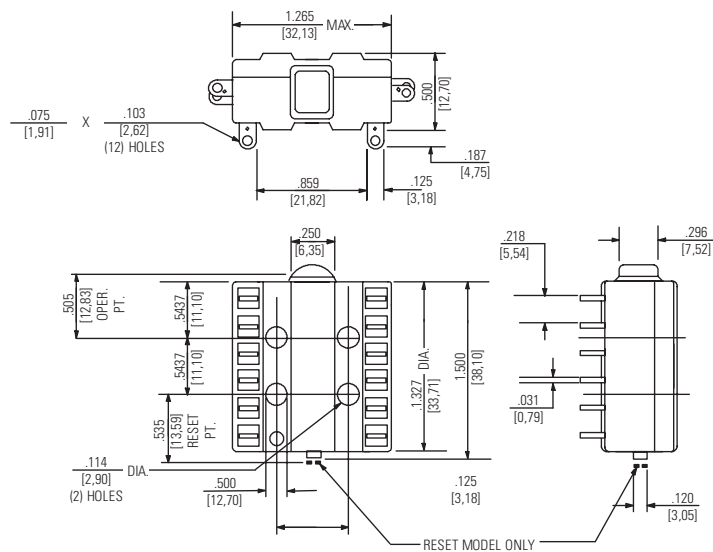

Series K

**STANDARD**  
0.00 = inches  
[0,0] = mm

Dimensions for reference only.